

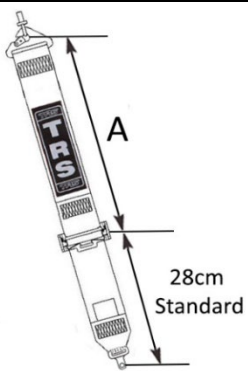

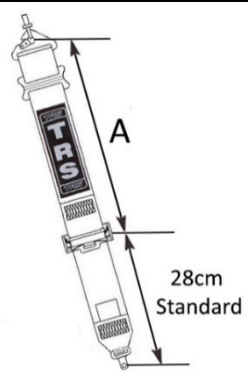

Date:		<b>Harness Specification Sheet</b>
Dealer Name:		
Customer Name:		
Daytime Contact No:		
Email Address:		
Approval Type:	Qty required:	Colour:

Make of Vehicle:	Type:	Year:
------------------	-------	-------

**Shoulder strap measurements "A" should be taken with driver seated in vehicle with harness fastened tight.**  
 TRS Technical Tip: Shoulder measurements "A" under 65cm TRS recommend a Sewn Bearing Point

Sewn Bearing Point <input type="checkbox"/>	Threaded Anchor Point with 3 Bar Slide <input type="checkbox"/>	<b>Shoulder Webbing Width:</b> FHR Specific 50mm <input type="checkbox"/> 75mm <input type="checkbox"/>	<b>Length A:           cm</b>  Measure distance "A" from centre of anchor mounting point to centre of adjuster
			

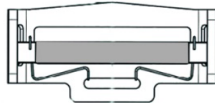
**Shoulder Adjuster (Mark appropriate box)**  
 TRS Technical Tip: TRS Recommend the aluminium adjuster for fast and easy adjustment

75mm Steel Adjuster <input type="checkbox"/>	75mm Aluminium Adjuster <input type="checkbox"/>
	

**Lap Straps - Measurements should be taken with the harness fastened tight and adjustment in midway position.**  
 "B" is 50cm as standard from centre of anchor mounting to centre of release buckle.  
 "C" is 12cm as standard from centre of mounting strap to centre of adjuster.

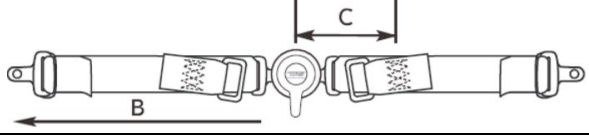
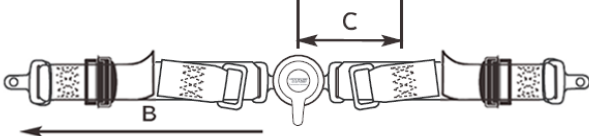
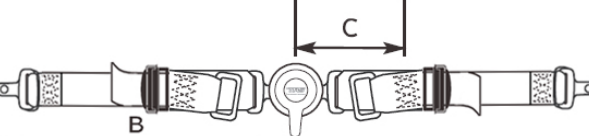
Single Seater Lap (STD) <input type="checkbox"/>		<b>Length B:</b> (Overall Length) <b>cm</b> <b>Length C:</b> (12cm STD) <b>cm</b>
Pull Up (with aluminium adjusters) <input type="checkbox"/>		<b>Length B:</b> (Overall Length) <b>cm</b> <b>Length C:</b> (12cm STD) <b>cm</b>
Pull Down (with aluminium adjusters) <input type="checkbox"/>		<b>Length B:</b> (Overall Length) <b>cm</b> <b>Length C:</b> (12cm STD) <b>cm</b>

**Lap Adjuster**  
 TRS Technical Tip: TRS Recommend the aluminium adjuster for fast and easy adjustment

**50mm Aluminium Adjuster**







**Rotary Quick Release Buckle Only**  
 Permanently fixed to right hand lap strap (Standard for single seater or 4 point saloon)

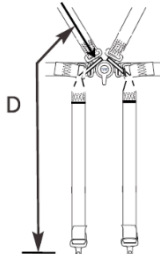

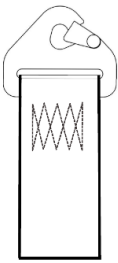
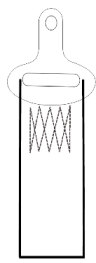
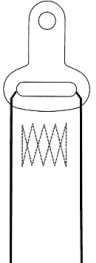
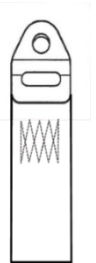
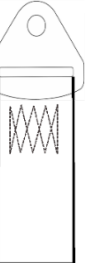
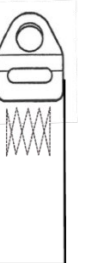
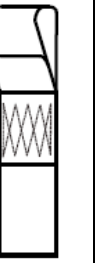
**50mm Crutch Straps - Measurements should be taken with the driver seated in the vehicle.**  
**Single Seater Crutch**  
 "D" is 65cm as standard.

Pull Down <input type="checkbox"/>		Length D: <span style="float: right;">cm</span>
------------------------------------	---	---

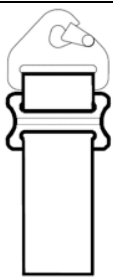
Sewn Anchorages - Mark appropriate boxes to identify requirements							
Sewn Snap Hook	Sewn 8mm Bolt in Plate	Sewn 9.5mm Bolt in Plate	Sewn 11mm Bolt in Plate	Sewn 13mm Bolt in Plate	Sewn 15mm Bolt in Plate	Sewn Flat Loop <small>4cm is standard</small>	Sewn Pinched Becket
							
<input type="checkbox"/>	<input type="checkbox"/>	<input type="checkbox"/>	<input type="checkbox"/>	<input type="checkbox"/>	<input type="checkbox"/>	<input type="checkbox"/>	
<input type="checkbox"/>	<input type="checkbox"/>	<input type="checkbox"/>	<input type="checkbox"/>	<input type="checkbox"/>	<input type="checkbox"/>	<input type="checkbox"/>	<input type="checkbox"/>
	<input type="checkbox"/>	<input type="checkbox"/>	<input type="checkbox"/>	<input type="checkbox"/>	<input type="checkbox"/>	<input type="checkbox"/>	
							FHR 50mm Shoulder Straps
							75mm Shoulder Straps
							50mm Lap Straps

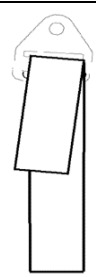
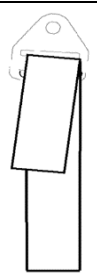
Threaded Anchorages - Mark appropriate boxes to identify requirements				
Snap Hook + 3 Bar Slide	13mm Bolt in Plate + 3 Bar Slide	8mm Bolt in Plates as Pinch Plates	13mm Bolt in Plates as Pinch Plates	10mm Bolt in Plates as Pinch Plates
				
<input type="checkbox"/>	<input type="checkbox"/>		<input type="checkbox"/>	
<input type="checkbox"/>	<input type="checkbox"/>			
<input type="checkbox"/>	<input type="checkbox"/>	<input type="checkbox"/>	<input type="checkbox"/>	<input type="checkbox"/>
<input type="checkbox"/>	<input type="checkbox"/>	<input type="checkbox"/>	<input type="checkbox"/>	<input type="checkbox"/>
				FHR 50mm Shoulder Straps
				75mm Shoulder Straps
				50mm Lap Straps
				50mm Crutch Straps